

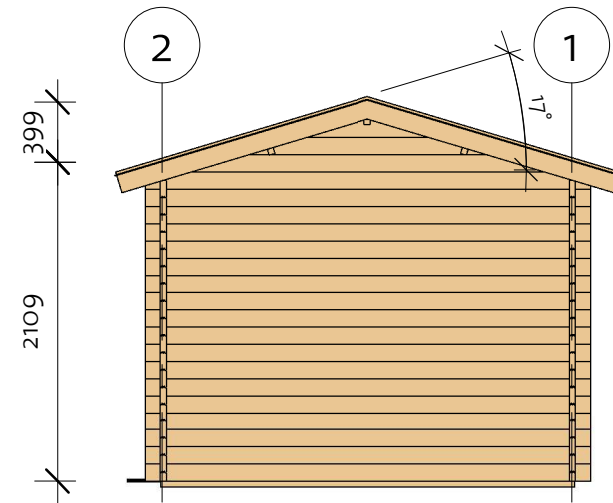

Wrexham 2 40 (450x275)

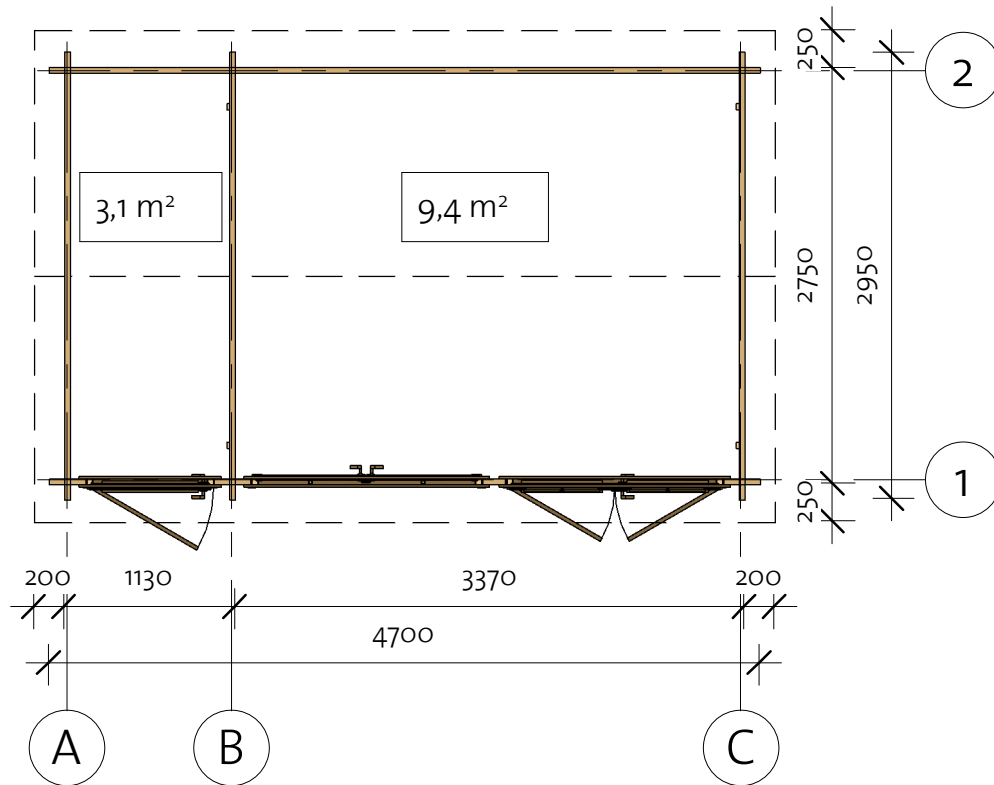
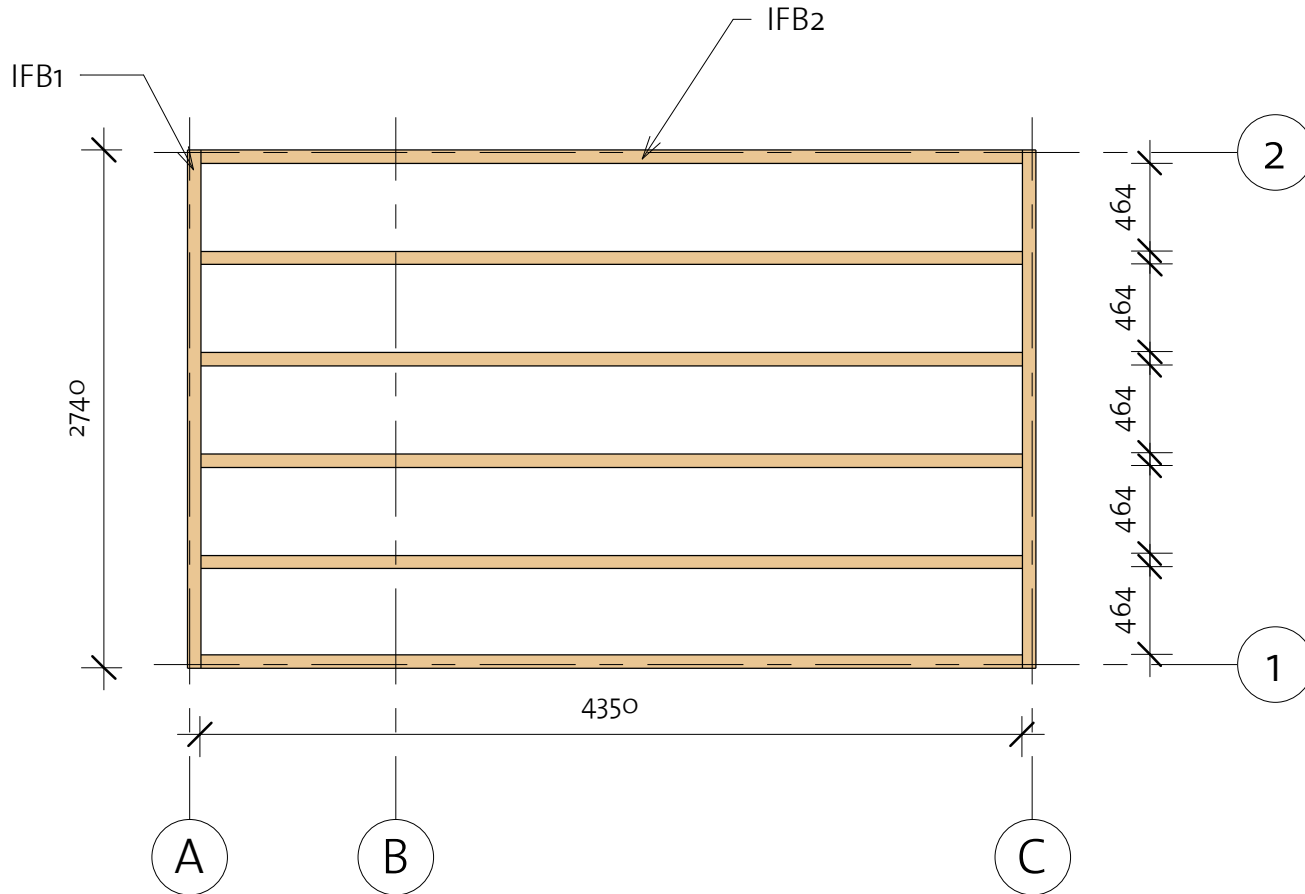

Wrexham 2 40 (450x275)

Foundation



Impregnated foundation beams				
Mark	Type	Profile	Count	Length
IFB1	IFB 70x40		2	2740
IFB2	IFB 70x40		6	4350

Wrexham 2 40 (450x275)

Floor Plan

① Baseboard

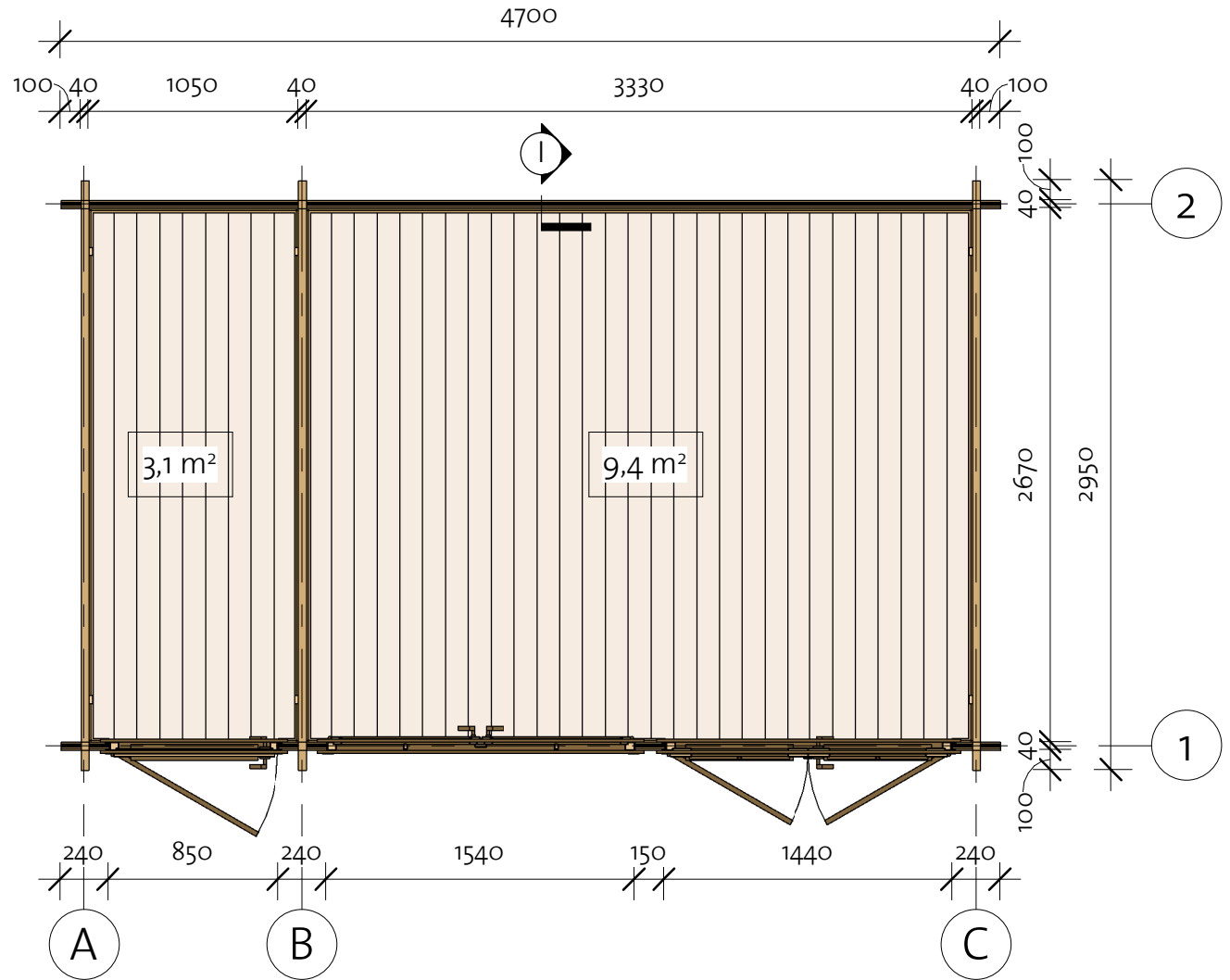
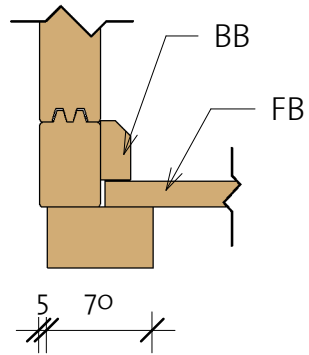

Floor Schedule

Mark	Type	Profile	Count	Length
------	------	---------	-------	--------

FB	FB 17x114		40	2664
----	-----------	---	----	------

BB	BB 20x40		2	4500
BB	BB 20x40		4	2750

Wrexham 2 40 (450x275)

Wall 1

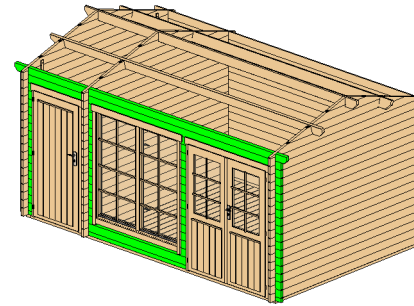

Wall 1			
Mark	Profile	Count	Cut Length

1BL-1	40X57	2	240
1BL-2	40X57	1	1930
1LG-1	40X114	14	150
1LG-2	40X114	46	240
1LG-3	40X114	2	1930
1LG-4	40X114	1	4700
1TL-1	40X114	1	4900

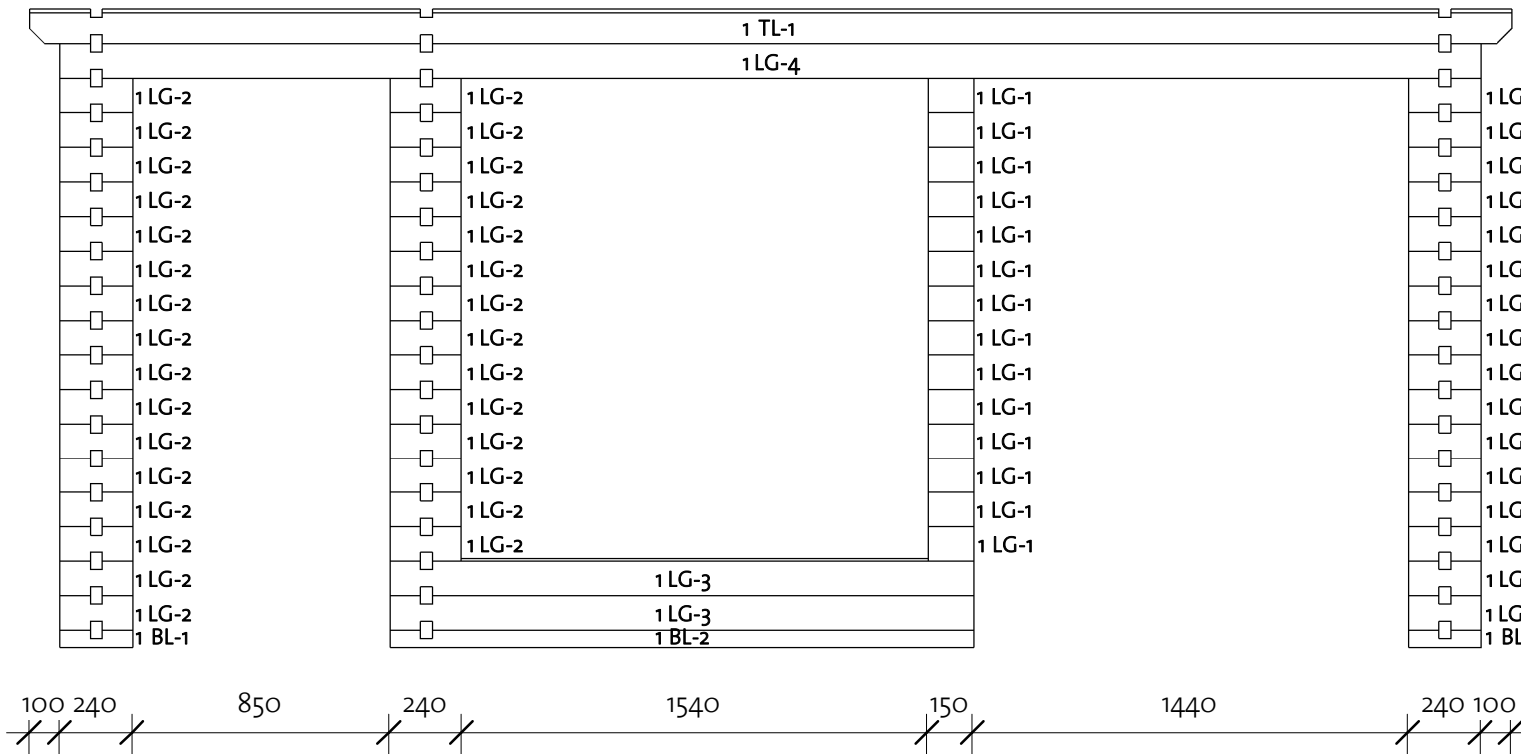

Log Profile Wall 1	
Profile	Profile

40X57	
40X114	
40X114	

Wrexham 2 40 (450x275)

Wall 2

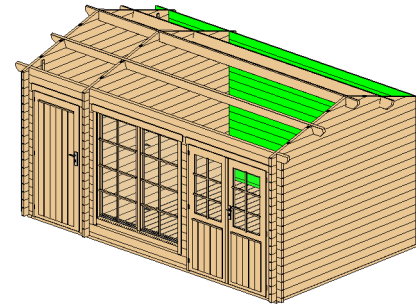

Wall 2			
Mark	Profile	Count	Cut Length

2BL-1	40X57	1	4700
2LG-1	40X114	17	4700
2TL-1	40X114	1	4900

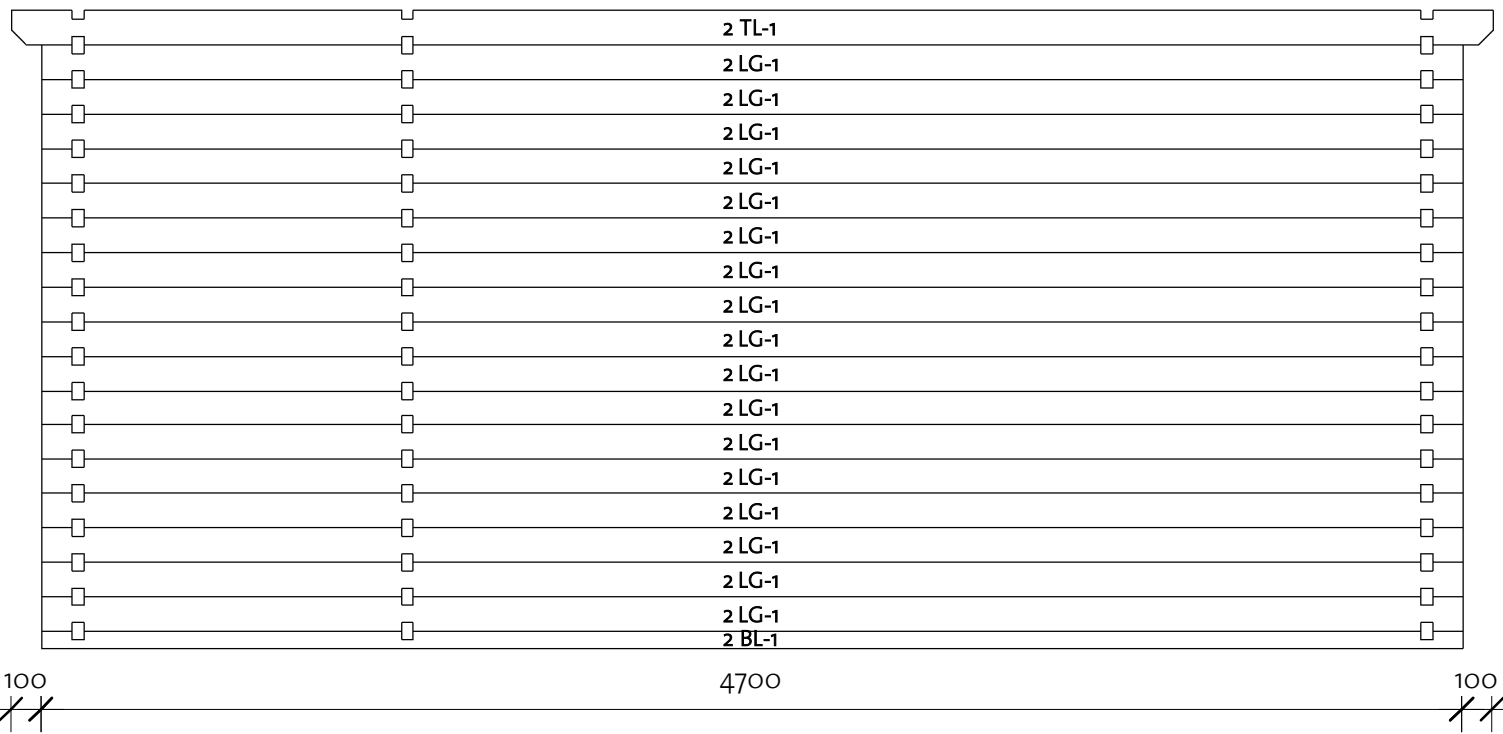

Log Profile Wall 2	
Profile	Profile

40X57	
40X114	
40X114	

Wrexham 2 40 (450x275)

Wall A

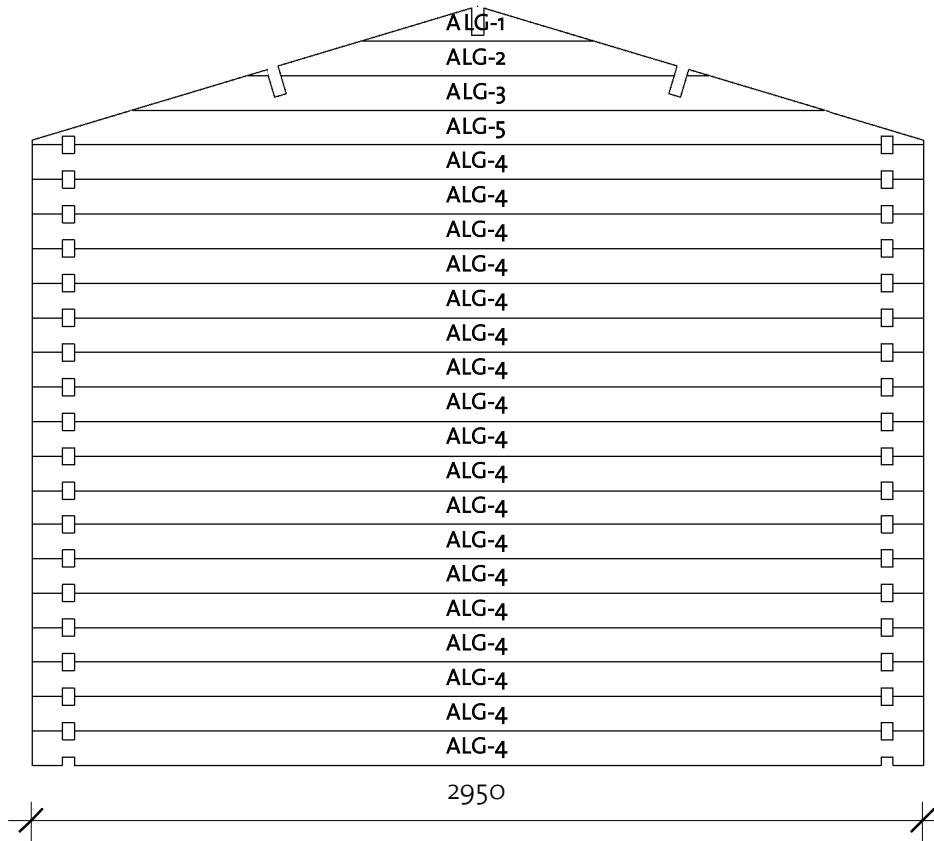
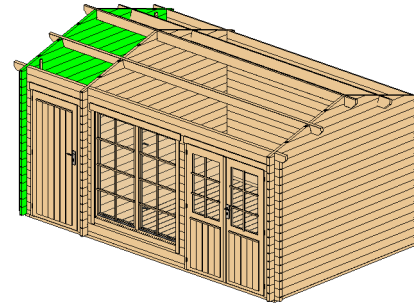

Wall A			
Mark	Profile	Count	Cut Length

ALG-1 *	40x114	1	765
ALG-2 *	40x114	1	1527
ALG-3 *	40x114	1	2289
ALG-4	40x114	18	2950
ALG-5 *	40x114	1	2950

* Gable - delivered premounted

Log Profile Wall A	
Profile	Profile

40x114	
--------	--

Wrexham 2 40 (450x275)

Wall B

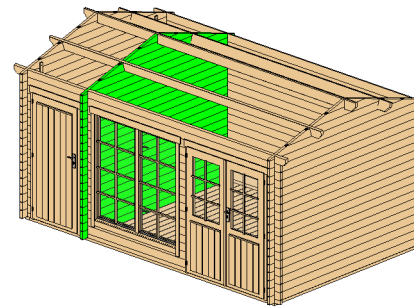

Wall B			
Mark	Profile	Count	Cut Length

BLG-1 *	40X114	1	765
BLG-2 *	40X114	1	1527
BLG-3 *	40X114	1	2289
BLG-4	40X114	18	2950
BLG-5 *	40X114	1	2950

* Gable - delivered premounted

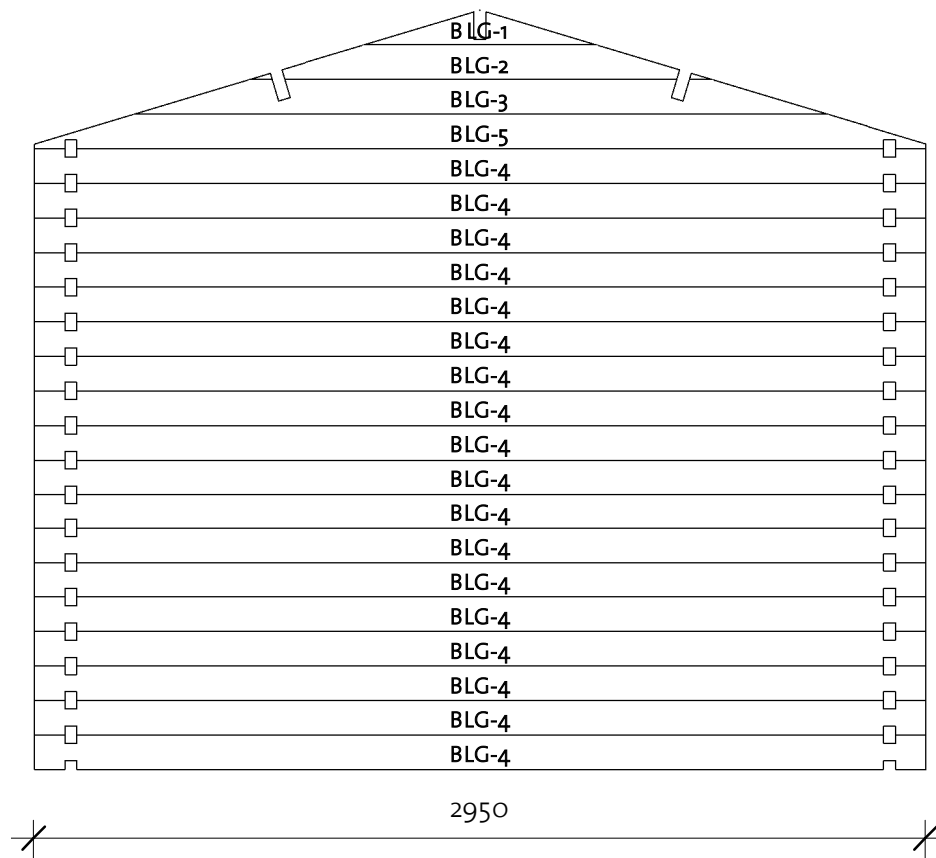

Log Profile Wall B	
Profile	Profile

40X114	
--------	--

Wrexham 2 40 (450x275)

Wall C

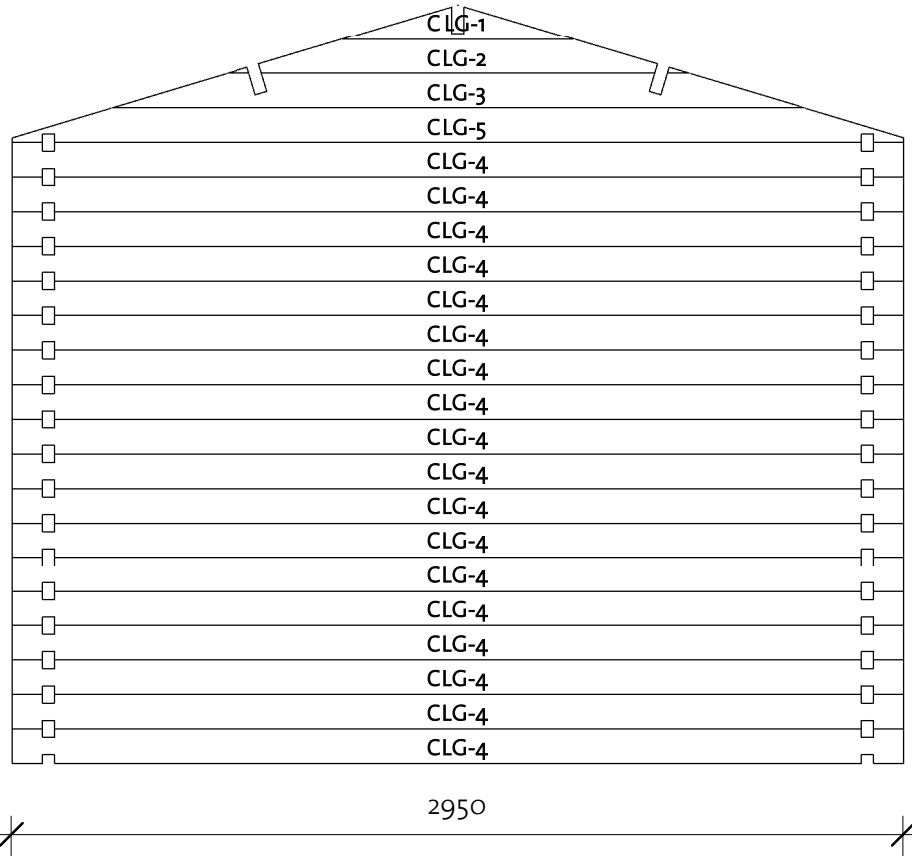
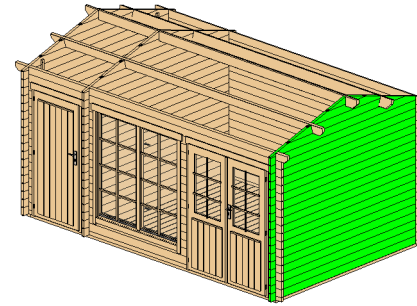

Wall C			
Mark	Profile	Count	Cut Length

CLG-1*	40x114	1	765
CLG-2*	40x114	1	1527
CLG-3*	40x114	1	2289
CLG-4	40x114	18	2950
CLG-5*	40x114	1	2950

* Gable - delivered premounted



Log Profile Wall C	
Profile	Profile

40x114	
--------	--

Wrexham 2 40 (450x275)

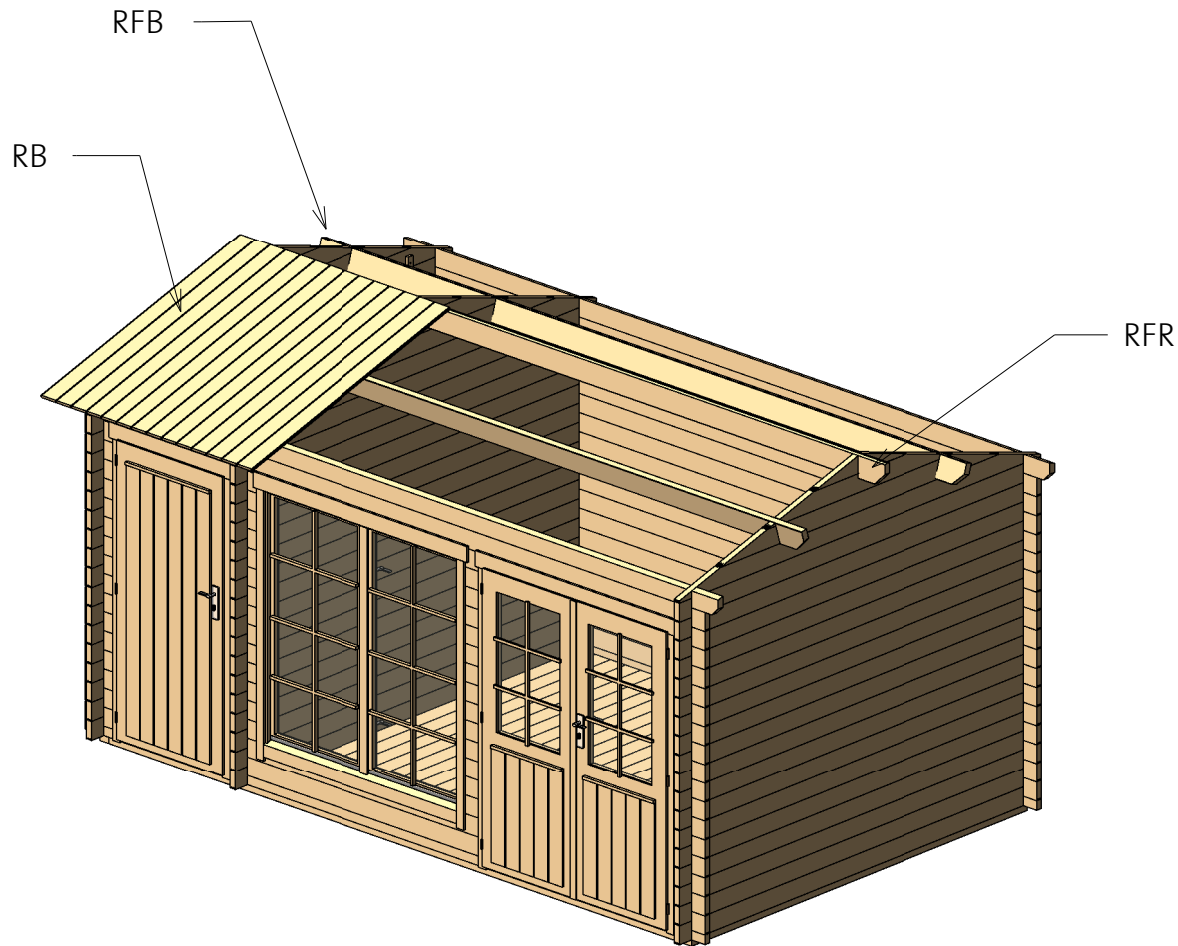
Roof 1



Roof				
Mark	Type	Profile	Count	Length
RB	17x114		88	1691
RFB	Beam 40x143		2	4900
RFR	Ridge 40x143		1	4900

Wrexham 2 40 (450x275)

Roof 2

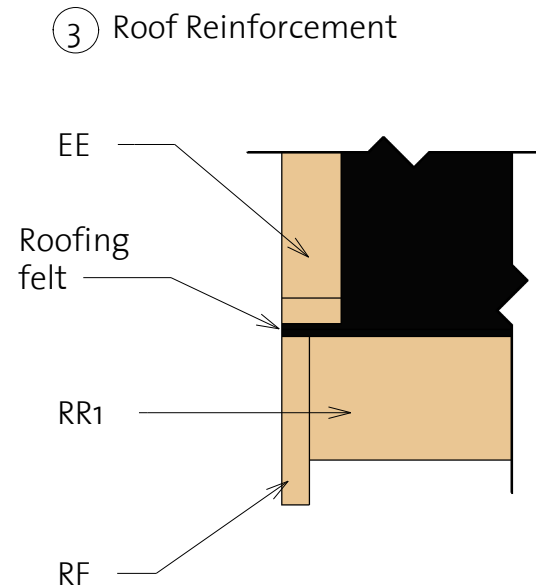
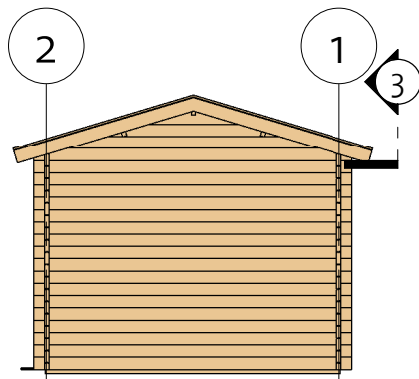
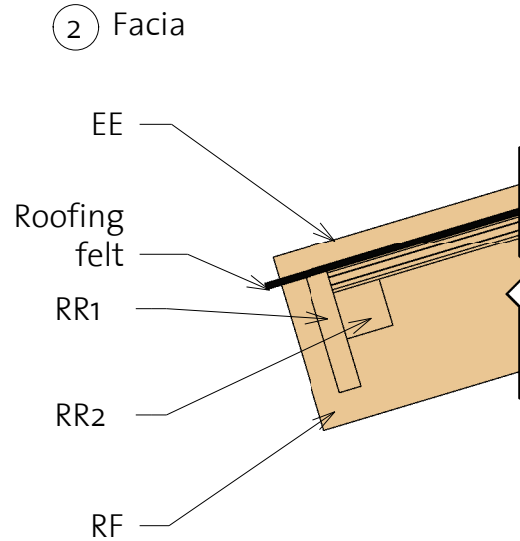
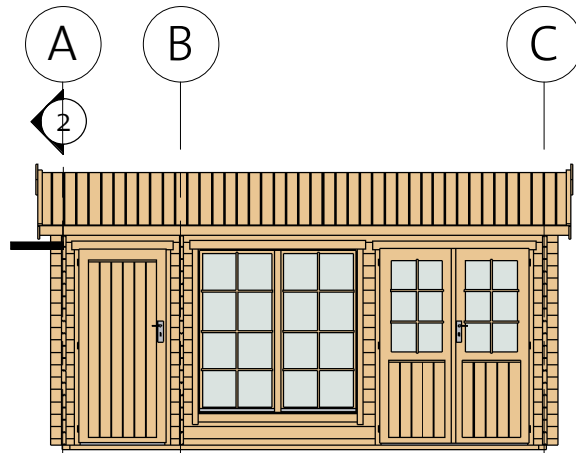

Fascia Schedule				
Mark	Type	Profile	Count	Length
EE	Eave Edging 18x40		4	1735
RF	Roof Fascia 18x120		4	1735
RR1	Roof reinforcement 18x95		2	4900
RR2	Roof reinforcement 38x38		2	4900

Wrexham 2 40 (450x275)

Extras



Door Schedule				
Model	Type	Width	Height	Count
CDD12R	Classic double door 12 right	1425	1835	1
CD11L	Classic door 11, wood left	840	1835	1
DCB6	Door Crossbar 6	--	--	2

Window Schedule				
Mark	Type	Height	Width	Count
CDW4	Classic double window 4	1555	1530	1
WCB8	Windows Crossbar 8	--	--	2

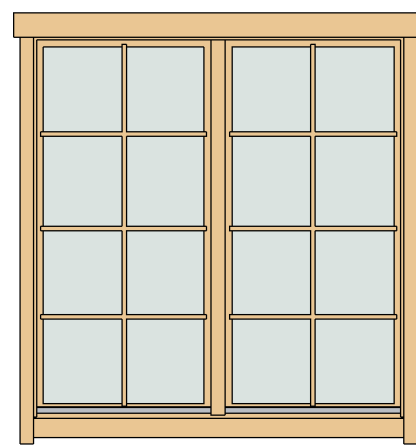

Fasteners/Extras		
Name	Type	Count

Hitblock	300-400 mm	
Screws	5,0 x 70	15
Bolts	M8x70	18
Screws	6,0 x 140	50
Nails	1,4 x 40	60
Screws	4,0 x 40	670

Type	Count
Romb	2



Type	Count	Length
Windboard 18x40	6	2200





- * Windows intended for tilt opening only!
- * Fenster zur Eröffnung nur zum Kippen vorgesehen!
- * Aknad on ette nähtud ainult kaldu avamiseks!



Wrexham 2 40 (450x275)

List of all items 1



Impregnated foundation beams

Mark	Type	Profile	Count	Length
IFB1	IFB 70x40		2	2740
IFB2	IFB 70x40		6	4350





Roof

Mark	Type	Profile	Count	Length
RB	17x114		88	1691
RFB	Beam 40x143		2	4900
RFR	Ridge 40x143		1	4900

Floor Schedule

Mark	Type	Profile	Count	Length
FB	FB 17x114		40	2664
BB	BB 20x40		2	4500
BB	BB 20x40		4	2750

Fascia Schedule

Mark	Type	Profile	Count	Length
EE	Eave Edging 18x40		4	1735
RF	Roof Fascia 18x120		4	1735
RR1	Roof reinforce ment 18x95		2	4900
RR2	Roof reinforce ment 38x38		2	4900

Wrexham 2 40 (450x275)

List of all items 2

Wall A			
Mark	Profile	Count	Cut Length

ALG-1 *	40x114	1	765
ALG-2 *	40x114	1	1527
ALG-3 *	40x114	1	2289
ALG-4	40x114	18	2950
ALG-5 *	40x114	1	2950

Wall C			
Mark	Profile	Count	Cut Length

CLG-1*	40x114	1	765
CLG-2*	40x114	1	1527
CLG-3*	40x114	1	2289
CLG-4	40x114	18	2950
CLG-5*	40x114	1	2950

Wall 1			
Mark	Profile	Count	Cut Length

1BL-1	40x57	2	240
1BL-2	40x57	1	1930
1LG-1	40x114	14	150
1LG-2	40x114	46	240
1LG-3	40x114	2	1930
1LG-4	40x114	1	4700
1TL-1	40x114	1	4900

Wall B			
Mark	Profile	Count	Cut Length



BLG-1 *	40x114	1	765
BLG-2 *	40x114	1	1527
BLG-3 *	40x114	1	2289
BLG-4	40x114	18	2950
BLG-5 *	40x114	1	2950

* Gable - delivered premounted

Wall 2			
Mark	Profile	Count	Cut Length

2BL-1	40x57	1	4700
2LG-1	40x114	17	4700
2TL-1	40x114	1	4900

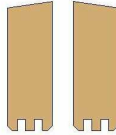
Log profiles	
Profile	Profile

40x57	
40x114	
40x114	

Windboard

① Windboard Assembly 1



② Windboard Assembly 2

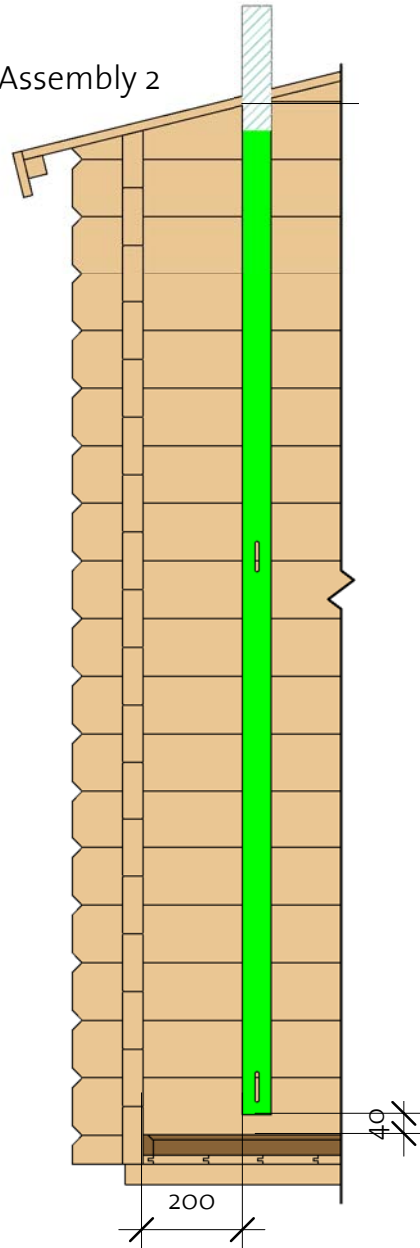

③ Windboard Assembly 3

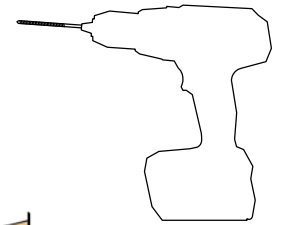
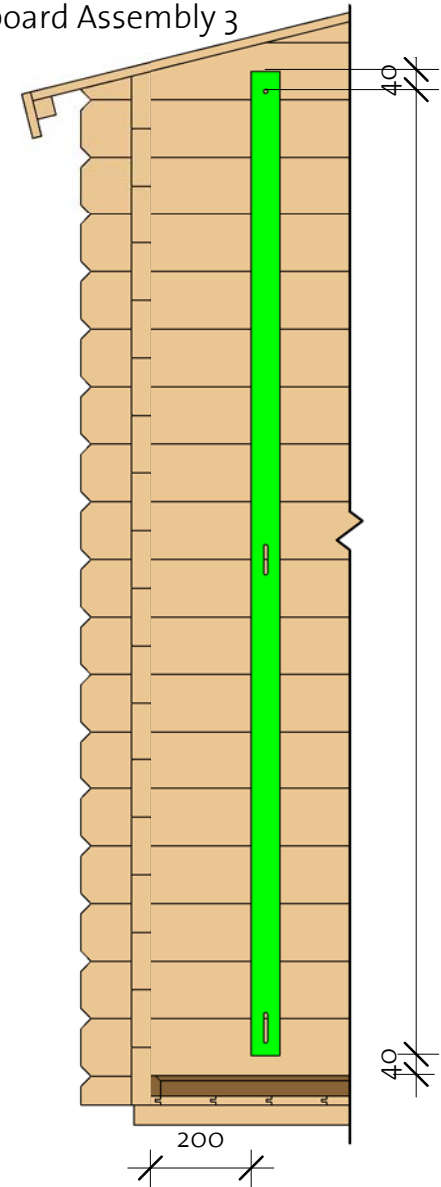

Ø 8mm